

Specifications

Advanced Flexible Mounter LX-8				
		P20Sx2	P20SxTakumi	TakumixTakumi
Board size	Single clamping	50x50 ~ 410x400 mm /500 mm *1		
	Double clamping	50x50 ~ 810x400 mm /500 mm *1		
Component height		3 mm	25 mm	
Component size	Maximum	0201		03015
	Minimum	□5 mm □65 mm /10 mm x90 mm /50 mm x75 mm		
Placement size (optimum)		105,000CPH	99,500CPH	94,000CPH
Placement accuracy		±40 μm (25 μm*) (Cpk≥1)		±30 μm (Cpk≥1)*3
Feeder capacity	Tape	Max. 160*4		
	Tray	—	Max. 30	Max. 60
Power		3-phase AC200V, 220V~430V*5		
Apparent power		2.49 kVA		
Operating air pressure		0.5±0.05MPa		
Air consumption (standard)		50L /min (ANR)		
Machine dimensions (WxDxH)*6		1,600 mm x1,800 mm x1,440 mm		
Mass (approximately)		2,500kg		

*1 Factory default
 *2 Image recognition, high-precision mode
 *3 For image recognition
 *4 Please contact for details
 *5 220V - 430V requires a separate transformer
 *6 D dimension does not include the front operation monitor. H dimension does not include signal tower.

Options

Advanced Flexible Mounter LX-8	
Recognitions system	54 mm view camera
Inspection function	Coplanarity sensor / Component Verification System(CVS)*5
Conveyor	Support pin
Electrical protection	CE compatible specification / Ground-fault interrupter
Software*	JaNets / IFS-NX / Flexline CAD
Component handling and feeders	Electric tape feeder (RF)
Others	Electric stick feeder (Type-N) / Matrix tray server TR8SR / Matrix tray changer TR6DENV / Dual tray server TR1RB / Tray Holder / Tape reel mounting base(for RF) / Splicing jig / Electric Trolley Power Station (PW02)* / RS-1R • RS-1 nozzles(with RFID tags) / Big foot / FCS calibration jig

* Please contact for details.

Advanced Flexible Mounter

LX-8



maxtronix, inc.

JUKI

JUKI Smart Solutions

Achieves high-efficiency production through high area productivity and ultra-high speed equipment of the highest level in its class

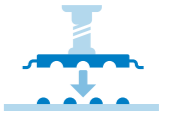

SOFTWARE



STORAGE



PRINTING



INSPECTION



PLACEMENT



INSERTION



SOLDERING

High Productivity
 High Flexibility
 High Quality



maxtronix, inc.

#1 Mon-el St., Mon-el Subd., Dr. A. Santos Ave., Brgy. San Antonio, Paranaque City, Philippines 1715

Tel: (+632) 8820-6329

Fax: (+632) 8820-4839

Website: www.maxtronix.net



JUKI SMT SITE



MS CM01



EMS (P) 14021 JSAE389

JUKI CORPORATION HEAD OFFICE
 The activities of research, development, design, sales, distribution, and maintenance services of industrial sewing machines, household sewing machines and industrial robots, etc., including sales and maintenance services of data entry systems.

*Please refer to the product specifications for details.
 ■JUKI Specifications and appearance may be changed without notice.

MANUFACTURER : JUKI CORPORATION

INQUIRY : JUKI AUTOMATION SYSTEMS CORPORATION

2-11-1, Tsurumaki, Tama-shi, Tokyo 206-8551, JAPAN
 TEL.81-42-357-2293 FAX.81-42-357-2285

JUKI

www.juki.co.jp

THE FUSION CONCEPT

We want to simultaneously realize high-speed performance that overturns common sense and amazing versatility, and to raise the productivity of our customers to the utmost.

Advanced Flexible Mounter LX-8 was born from such strong wishes.

JUKI will constantly approach customers, evolve our customers' factories, and innovate in manufacturing as a partner that can dramatically advance our business.



Advanced Flexible Mounter LX-8

High Productivity

Achieves high-efficiency production through high area productivity and ultra-high speed equipment of the highest level in its class

It boasts the highest 105,000CPH in its class*, and is equipped with ultra-high speed, space-saving features, while boasting high area productivity and achieving highly efficient production.

With P20S head, high-speed and high-precision mounting of 105,000CPH* can be achieved with 0201 extremely small parts.

In addition, even large components and other highly versatile design heads can be equipped with ultra-high speed 94,000CPH that are among the highest in their class.

*For P20S head x 2



P20S head/design head, selectable for each characteristic

P20S head

P20S has a planet-head construction that sucks continuously with 20 nozzles. Even a tiny part of 0201 achieves stable suction reliability. In addition, the head height is variable (0.5 mm / 2 mm/3 mm) according to the component to achieve high-speed mounting in order to mount the component at the highest speed.

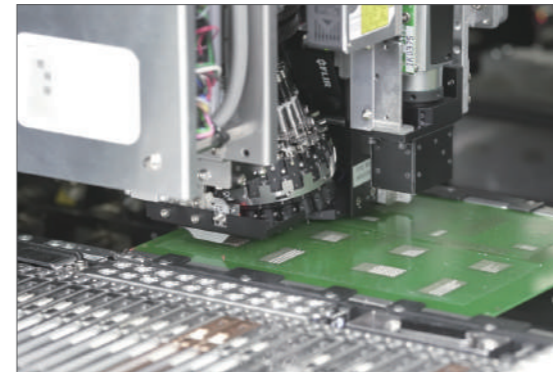

Takumi head

Takumi head, which realizes high-precision recognition by laser, has a variable centering unit according to the height of mounted parts. High-speed mounting is realized at the optimum height from very small parts to large parts.

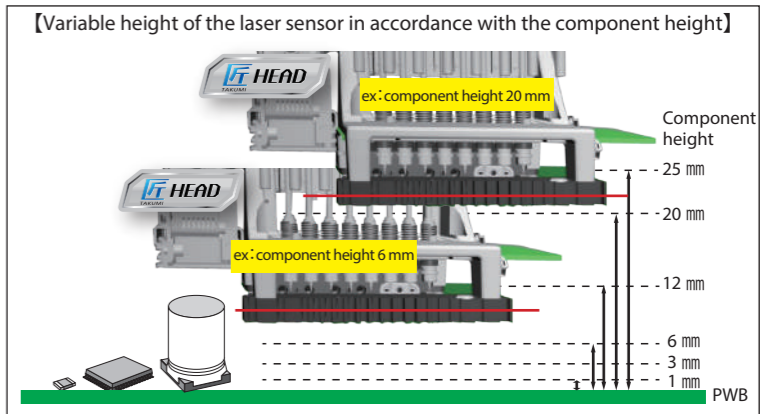

Front operation possible

LX-8 allows front-side banks to operate without loss of productivity.

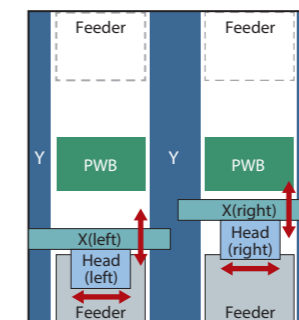

Independent head configuration with minimized tact loss

The complete independent head configuration and buffer station installation also reduces the latency-dependent tact loss.

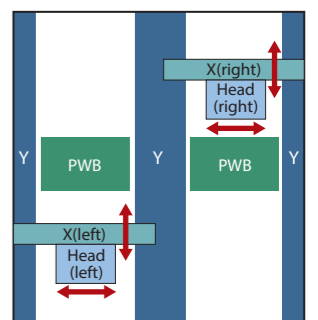

Feeder-mounted number-class No.1

The number of feeder slots is 160 or more, the highest in the class.* Since it is possible to set the next feeder for production in the feeder bank beforehand, the setup change time can be drastically shortened, and production preparation can be simplified and made more efficient.

*Contact us for details.

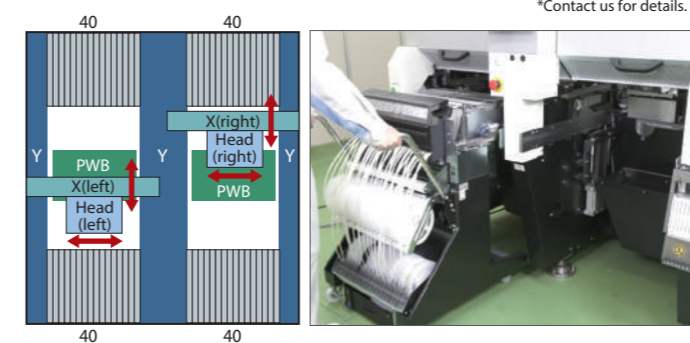

New User Interface pursuing ease of use

NEW

A smartphone-like operating feel that can be operated with intuition, color-conscious for all users and easy-to-view screens in dark themes, and high-priority functions have been placed on the top screen. This is a new type of operation panel that pursues ease of use.



High Flexibility

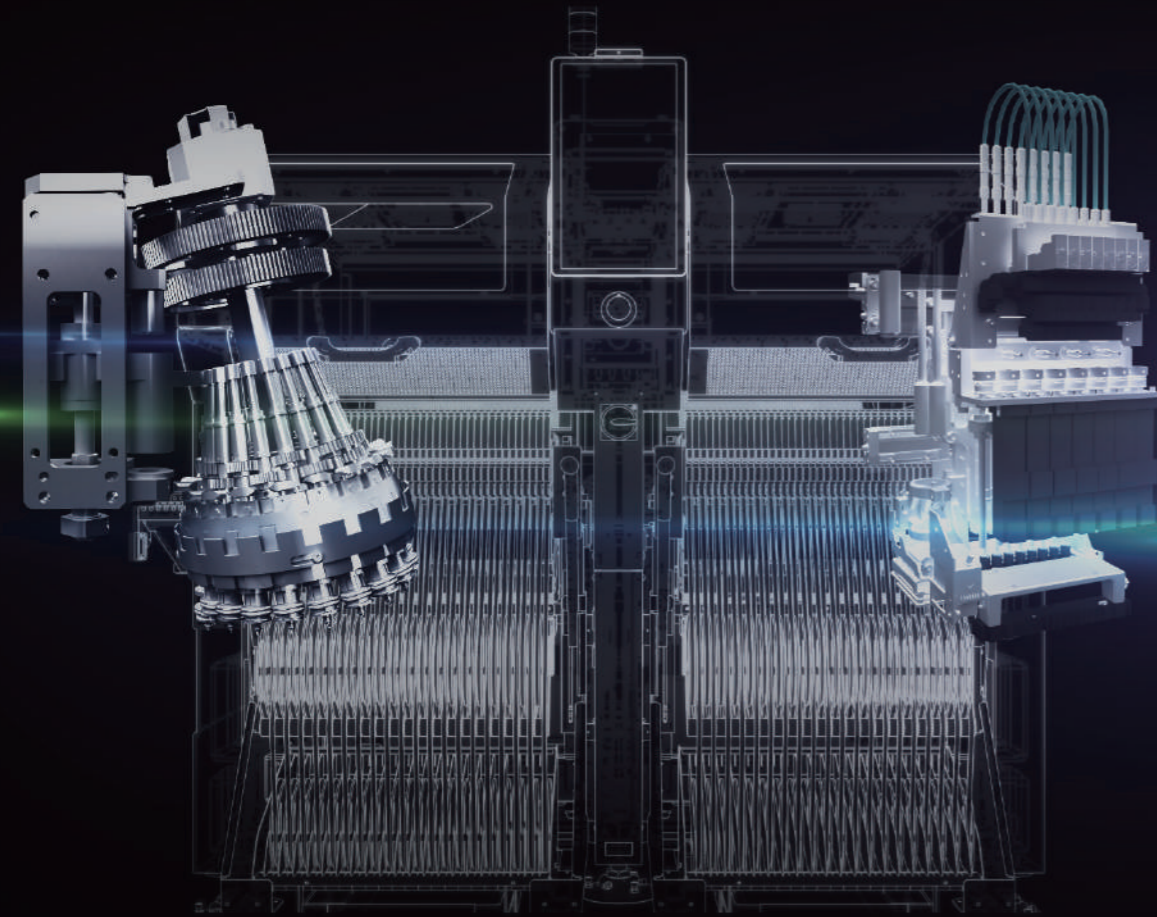

Flexible head configuration

Head can be replaced by the user. It can flexibly respond to changes in production boards.

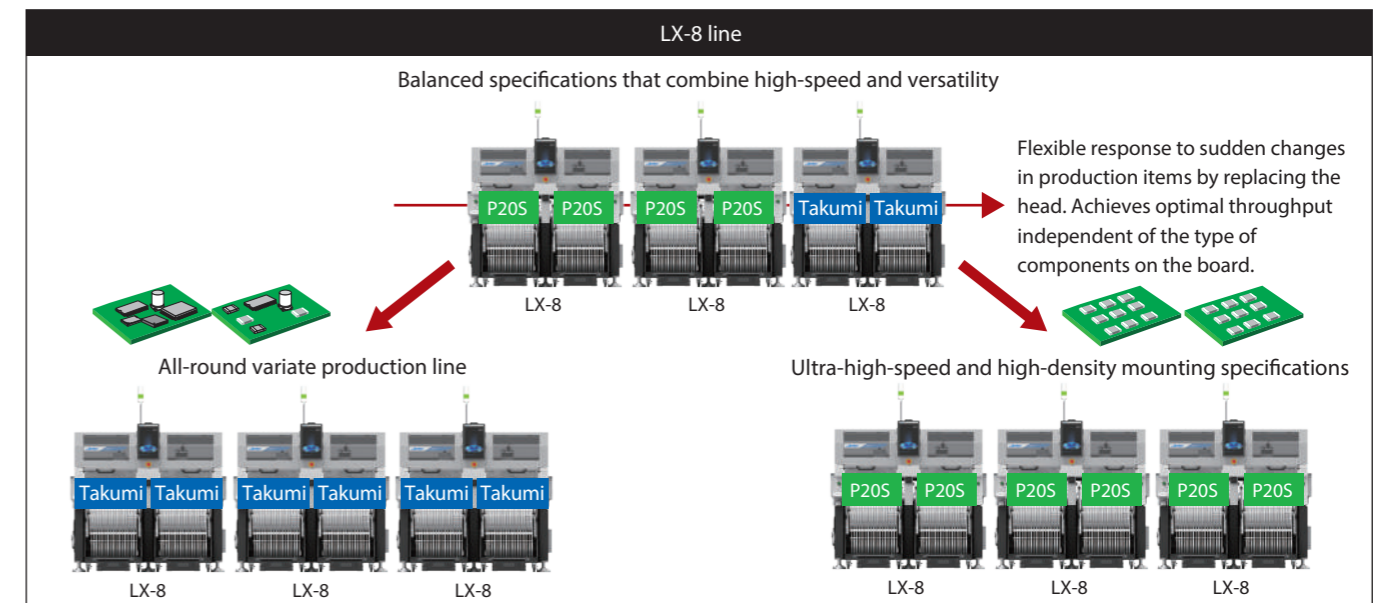

Line-up with the current JUKI mounter

By adding LX-8 to existing JUKI mounters, flexible line construction can be realized, including high-speed lines, high-speed general-purpose lines, and ultra-general lines.

- When LX-8 design head is mounted on the pre-existing RX-8

High-production general-purpose line with enhanced high-speed and general-purpose capabilities

RX-8+LX-8 mixing line

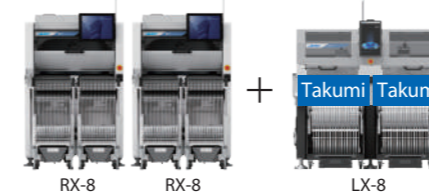

- When a LX-8 P20S head is added to a pre-existing RS-1R

Flexible and high-efficiency high-balance line that can be mounted on irregular shaped parts

LX-8+RS-1R mixing line



Wide component range

Supports components from 0201 *1 (metric) up to 65 mm square or 10 x 90 mm. In addition, component height up to 25 mm, so it is possible to mount a wide range of components.

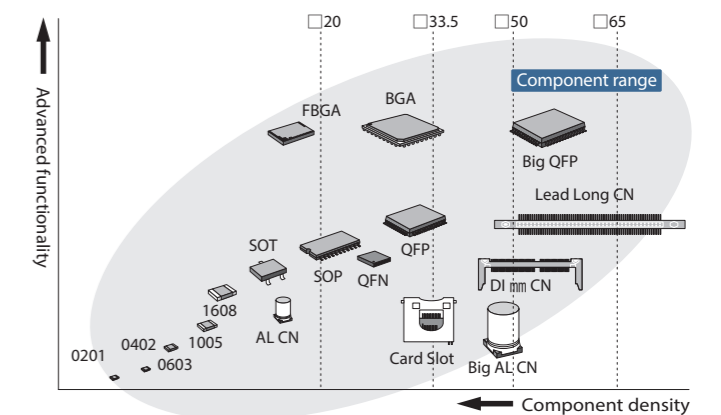

Large parts are supplied in trays

By using a tray server TR8 in which the main unit head sucks parts directly from the tray, it is possible to suck irregularly shaped parts such as connectors and heavy parts directly with the head.



Optimal for LED placement

With P20 Planet Head, stable recognition can be achieved even with continuous-mounting, enabling high-quality mounting for producing LED indicator lamps.



Easy head replacement

The head of LX-8 can be easily replaced in a short time.

By simply placing the heads optimally without changing the line layout, the machine can flexibly respond to variable and variable-quantity production.

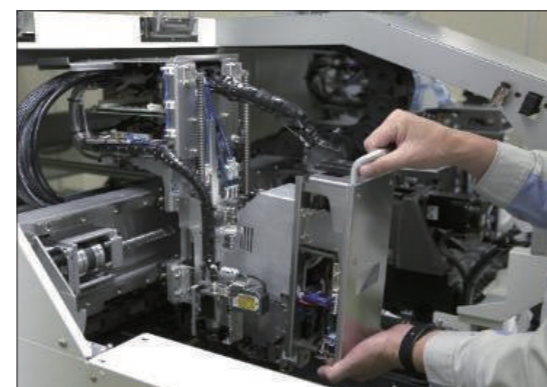

High Quality

State-of-the-art centering and inspection vision system P20S head

With P20S head, it is possible to detect the reversal of the front and back sides, inspect the tip standing, and detect the presence or absence of components. Realizes high-quality mounting of extremely small parts.

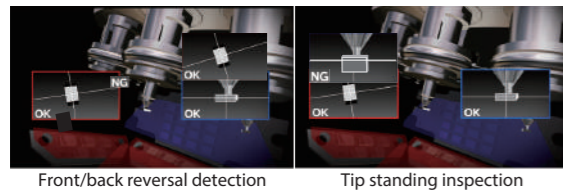

New high accuracy camera for inspection and centering

Coaxial lighting technology with a new structure enables clearer imaging and realizes high-precision onboard recognition.

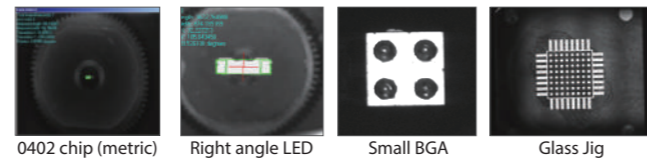

Realizes high-speed, high-precision recognition with JUKI's proud laser-recognition technique

03015 Capable of recognition various component shapes, such as PLCC, SOP, QFP from tiny components to 50mm square. Laser recognition realizes stable recognition and mounting without being affected by variations in parts such as electrode shape and gloss.

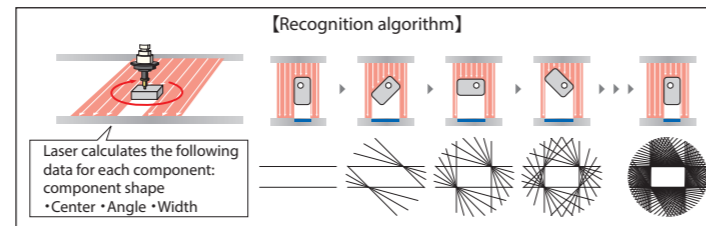

Reduction of VCS image-recognition times Takumi head

The adoption of an image-processing library HALCON has greatly reduced image-recognition times using VCS. It realizes high-speed recognition and mounting in not only chip components but also large components.

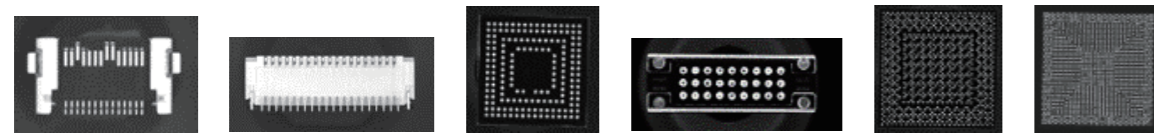

Component recognition technology Takumi head

Component shape, lead and ball details are accurately captured using our VCS camera. Component problems such as missing ball detection or bent leads are also detected. We can deal with not only QFP and BGA, but also irregular components in individual pattern-recognition.

- 360 degree part recognition technology
Components that are supplied incorrectly can be corrected and accurately placed using 360 degree recognition technology.
- Three color recognition lighting
The color of lighting can be changed to match the component requirements for stable, accurate centering.
- Wide component range
Hundreds of nozzles to choose from and flexible vision to support difficult parts. Simplified data creation make it easy to handle complex components.
- Faster image recognition
Reduction of image-recognition times through collective recognition of four nozzles using 54mm viewing angles

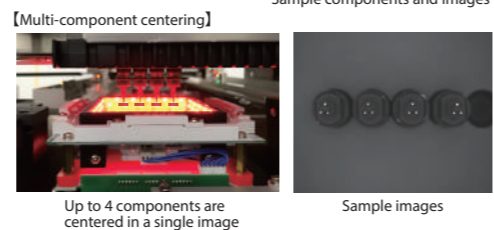
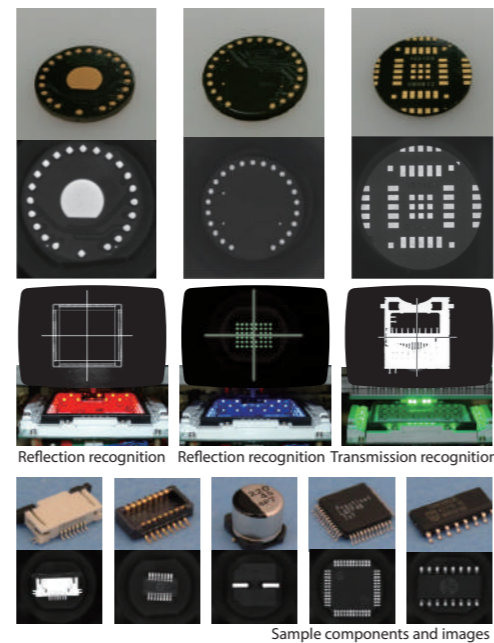

Low impact placement for flexible circuits

Low impact feature allows separately adjusting the down and up speed of the nozzle during placement. This minimizes the load on the part and on the board during placement. This is optimal for placing very small parts that require a lot of accuracy.

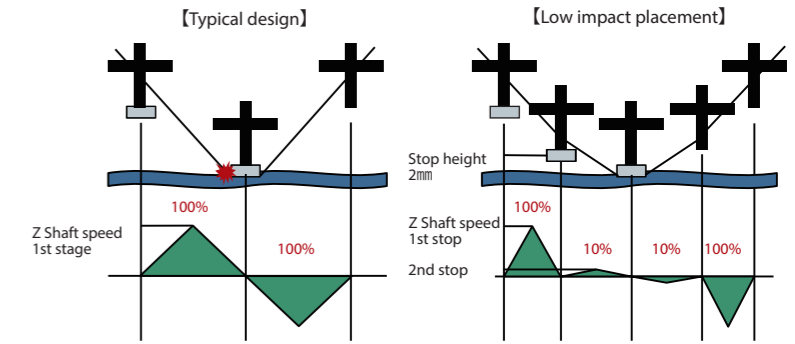
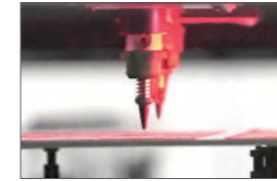

Operation rate improvement

High-performance CPU + Windows 10 has reduced the application startup time to about 1/4 compared to conventional machines.

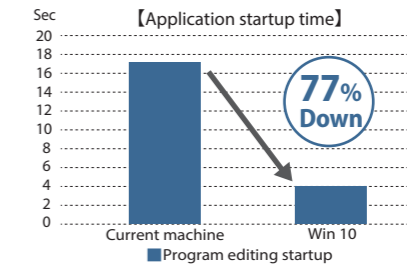

Integrates seamlessly with the production environment

SMT total system software JaNets and the system connected via JaNets help improve production efficiency across the entire plant by monitoring production status, storage-management, and remote-support. In addition, IFS-NX option enables high-quality production, such as traceability and component mis-mounting protection.

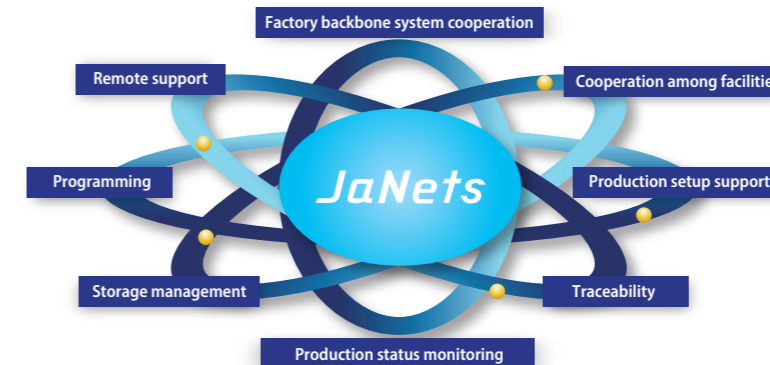

● Trace Monitor

The production status of boards can be checked hourly, and the operation rate, error occurrence status, etc. can be visually confirmed.

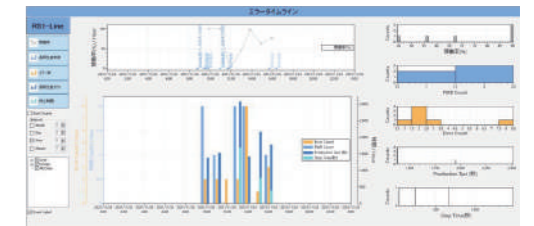

● Communicates and shares information with other equipment

Bad mark information of the circuit detected by the inspection machine or a machine upstream of the line can be propagated to the LX-8 in order to reduce the bad mark recognition time and improve productivity.

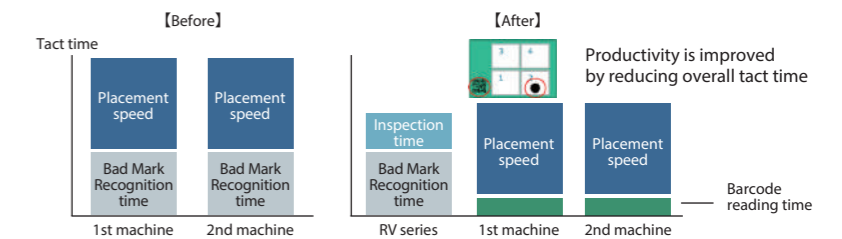

● Feed forward for printing misalignment*

The SPI results can be fed forward to the mounter and applied as a placement offset to reduce defects.
* Applicable models are RV series and LX-8

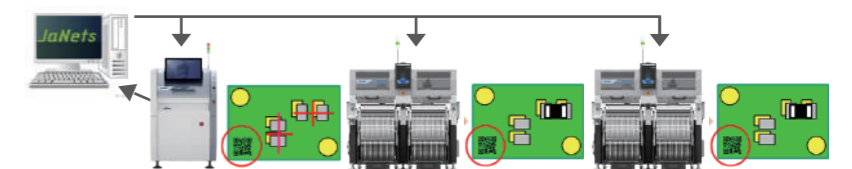

● Component Management with Auto replenishment

Efficient production can be achieved through various linkages, including parts management processes, such as automatic shipping of parts from automatic warehouses at the time of setup, as well as automatic shipping with warnings of parts shortage during production.

